



BLOWERS & FILLERS

ERGON





ONE SERIES, A HUNDRED POSSIBILITIES

Fruit juices

Carbonated water

Tea and isotonic drinks

Milk, yogurt
and dairy products



Carbonated drinks

Still water

Edible oil

Beer, wine and spirits

Detergents, cosmetics,
chemical and
pharmaceutical products

EBS ERGON SERIES

The new EBS (Electronic Blowing System) ERGON series of cam-free fully electronic stretch-blow moulders arises from SMI's 20-year-long experience in the manufacturing of rotary machines and is the outcome of a challenging Research & Development project lasted two years. The current EBS ERGON range comprises seven models from 4 to 16 cavities, capable of producing PET containers up to 3 L at the maximum output rate of 33,600 bottles/hour (0.5L format)*, and 3 HC models suitable for the production of high-capacity containers up to 10 L at the maximum output rate of 7,200 bottles/hour (5 L format)*.

* Depending on the machine model and container's features.



Technical specifications

	EBS 3 HC	EBS 4 HC	EBS 6 HC	EBS 4	EBS 6	EBS 8	EBS 10	EBS 12	EBS 14	EBS 16
MAX OUTPUT SPEED*	Up to 3.600 BPH	Up to 4.800 BPH	Up to 7.200 BPH	Up to 8.400 BPH	Up to 12.600 BPH	Up to 16.800 BPH	Up to 21.000 BPH	Up to 25.200 BPH	Up to 29.400 BPH	Up to 33.600 BPH
N° MOULDS	3	4	6	4	6	8	10	12	14	16
CONTAINER CAPACITY	Up to 10 L (min Ø = 44 mm max Ø = 215 mm)	Up to 10 L (min Ø = 44 mm max Ø = 215 mm)	Up to 10 L (min Ø = 44 mm max Ø = 215 mm)	Up to 3 L (min Ø = 44 mm max Ø = 120 mm)	Up to 3 L (min Ø = 44 mm max Ø = 120 mm)	Up to 3 L (min Ø = 44 mm max Ø = 120 mm)	Up to 3 L (min Ø = 44 mm max Ø = 120 mm)	Up to 3 L (min Ø = 44 mm max Ø = 120 mm)	Up to 3 L (min Ø = 44 mm max Ø = 120 mm)	Up to 3 L (min Ø = 44 mm max Ø = 120 mm)
	Up to 338.13 oz (min Ø = 1.73 in max Ø = 8.47 in)	Up to 338.13 oz (min Ø = 1.73 in max Ø = 8.47 in)	Up to 338.13 oz (min Ø = 1.73 in max Ø = 8.47 in)	Up to 101.44 oz (min Ø = 1.73 in max Ø = 4.72 in)	Up to 101.44 oz (min Ø = 1.73 in max Ø = 4.72 in)	Up to 101.44 oz (min Ø = 1.73 in max Ø = 4.72 in)	Up to 101.44 oz (min Ø = 1.73 in max Ø = 4.72 in)	Up to 101.44 oz (min Ø = 1.73 in max Ø = 4.72 in)	Up to 101.44 oz (min Ø = 1.73 in max Ø = 4.72 in)	Up to 101.44 oz (min Ø = 1.73 in max Ø = 4.72 in)
ELECTRICAL POWER	400 V +/-10% 3PH+N+PE 50/60Hz	400 V +/-10% 3PH+N+PE 50/60Hz	400 V +/-10% 3PH+N+PE 50/60Hz	400 V +/-10% 3PH+N+PE 50/60Hz	400 V +/-10% 3PH+N+PE 50/60Hz	400 V +/-10% 3PH+N+PE 50/60Hz	400 V +/-10% 3PH+N+PE 50/60Hz	400 V +/-10% 3PH+N+PE 50/60Hz	400 V +/-10% 3PH+N+PE 50/60Hz	400 V +/-10% 3PH+N+PE 50/60Hz
MACHINE SIZE**	4452 x 3460 x 2575 mm	5052 x 3460 x 2575 mm	5552 x 3460 x 2575 mm	4200 x 3500 x 2750 mm	4200 x 3500 x 2750 mm	4700 x 3500 x 2750 mm	5200 x 3500 x 2750 mm	6800 x 3900 x 2750 mm	6800 x 3900 x 2750 mm	6800 x 3900 x 2750 mm
	14.93 x 11.35 x 8.45 ft	16.57 x 11.35 x 8.45 ft	18.22 x 11.35 x 8.45 ft	13.78 X 11.48 X 9.02 ft	13.78 X 11.48 X 9.02 ft	15.42 X 11.48 X 9.02 ft	17.06 X 11.48 X 9.02 ft	22.31 x 12.8 x 9.02 ft	22.31 x 12.8 x 9.02 ft	22.31 x 12.8 x 9.02 ft
										

The stated values are not binding, as they have to be confirmed by SMI according to production conditions and preform/container technical specifications.

* 0.5 L container. ** Length x width x height. Without preforms hopper and unscrambler.

Operation

1 PREFORMS FEEDING

Through a lifting belt the preforms are transferred from the hopper to the orientator, that conveys them to an inclined guide, from where by gravitational fall they reach the spacing star-wheel at the infeed of the heating module.

Such wheel feeds the chain of mandrels; these latter, while revolving on themselves, "capture" the preforms and carry them all along the heating module's length.

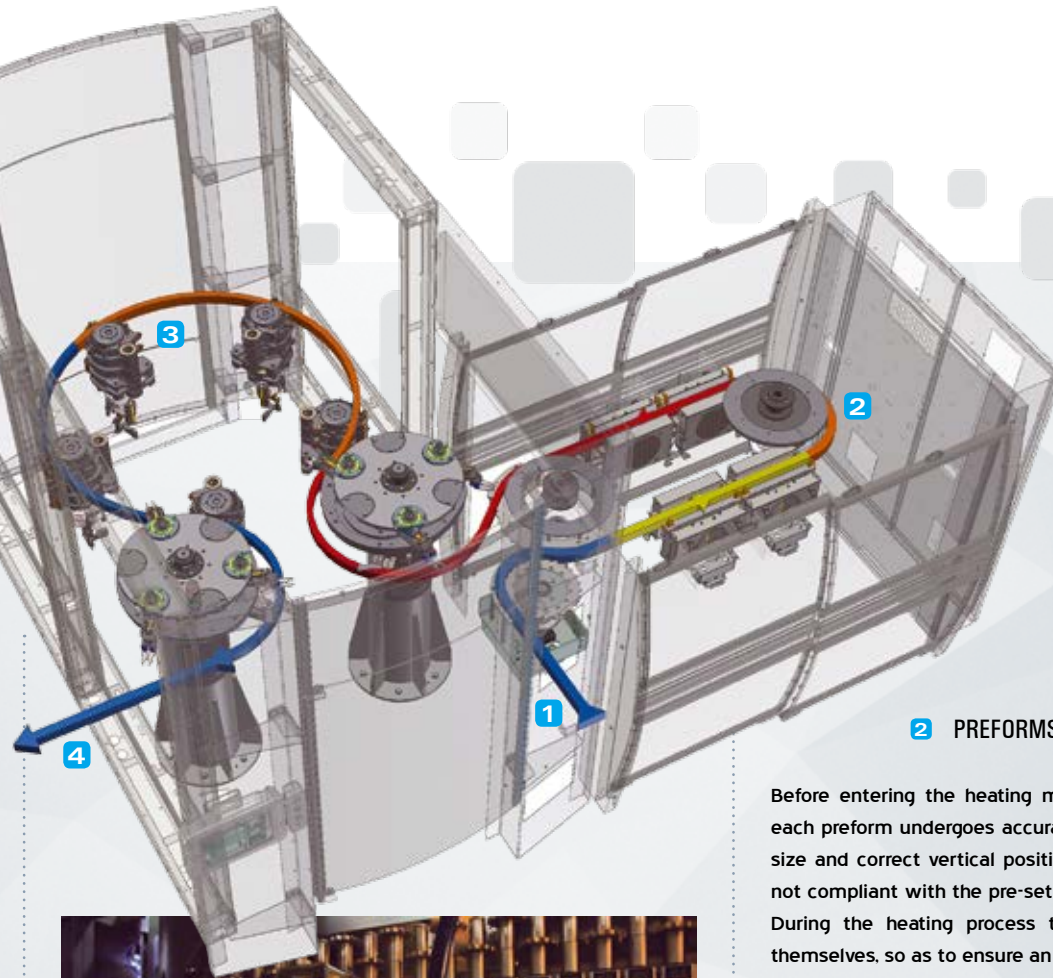

2 PREFORMS HEATING

Before entering the heating module, equipped with infrared lamps, each preform undergoes accurate checks, which detect the preform's size and correct vertical position and automatically discard it if it is not compliant with the pre-set parameters.

During the heating process the preforms constantly turn around themselves, so as to ensure an excellent and symmetrical distribution of the heat generated by the infrared ray lamps.

The heating module is equipped with two different cooling systems: a liquid-fed cooling system, in order to cool the protection ring that prevents the deformation of the preform neck thread during the heating process; an air-fed cooling system, in order to keep the temperature inside the heating module low enough as to avoid exposing the preform's external surface to overheating.

At the heating module outlet, a sensor detects the preform temperature, compares it with the temperature set point and, if the two values do not correspond, automatically increases or reduces the power of the infrared ray lamps.

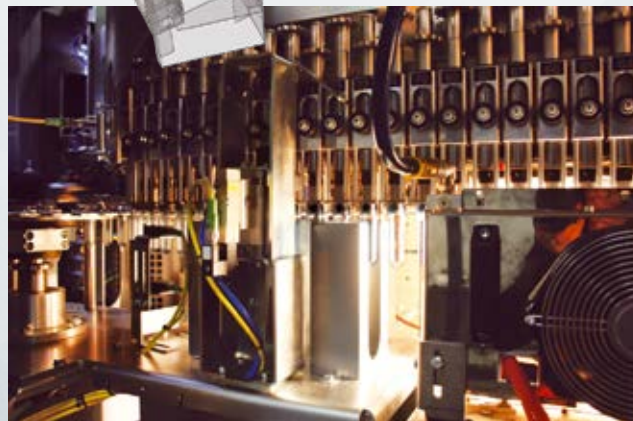

3 PREFORMS STRETCH BLOW-MOLDING

A special rotary group of grippers picks the preforms up from the heating module and sets them into the stretch-blowing stations. The stretch-blowing process includes two phases: stretching and pre-blowing, which occur simultaneously through the descent of the motorized stretching rod and the supply of low pressure compressed air, and final blowing with high-pressure compressed air, through which the containers take their final shape. A counter-pressure air system ensures the perfect locking of the moulds, whereas the mould mechanical group, paired with the electronic stretching rod, makes EBS ERGON stretch-blow moulders a truly "cam-free" machine and allows users to benefit from higher kinematic precision, reduced maintenance, less vibrations, low noise operations and longer life of the equipment.

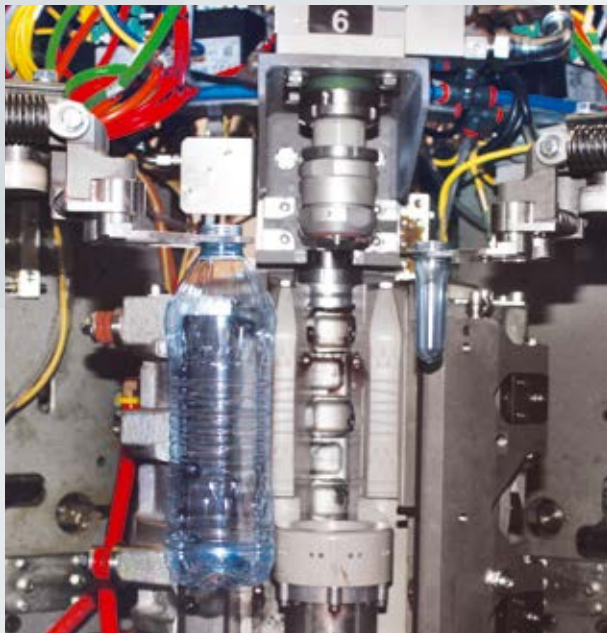

4 BOTTLES OUTLET

During the blowing process, an accurate measuring system checks the correctness of the pressure profile required throughout the bottle production process.

In fact, in case of pressure drop the container's shape changes and, thus, the machine's control system automatically discards flawed bottles.

The finished bottles are picked from the stretch-blowing stations by another rotary group of grippers which finally transfers them to the filling machines.



» Why to choose SMI rotary technology

- fully electronic blowing technology developed in order to reach high outputs and excellent performances
- accurate heating profile, differentiated for each preform
- single-cavity molds (they can contain one preform only)
- control and check of each mold and, consequently, of each cavity, by means of "Intellicavity" technology
- precise and constant monitoring of all phases of the stretch-blowing process, thanks to the specific parameters for each preform
- quick changeover and mold replacement

- reduction of the maintenance and operating costs

- low energy consumption, as the constant rotation of the blowing-wheel generates inertial loads almost equal to zero

- Low compressed air consumption, thanks to the air recovery system and to the low dead volume of each stretch-blowing station

- In case of failure, possibility to stop a stretch-blowing station, while keeping the machine running

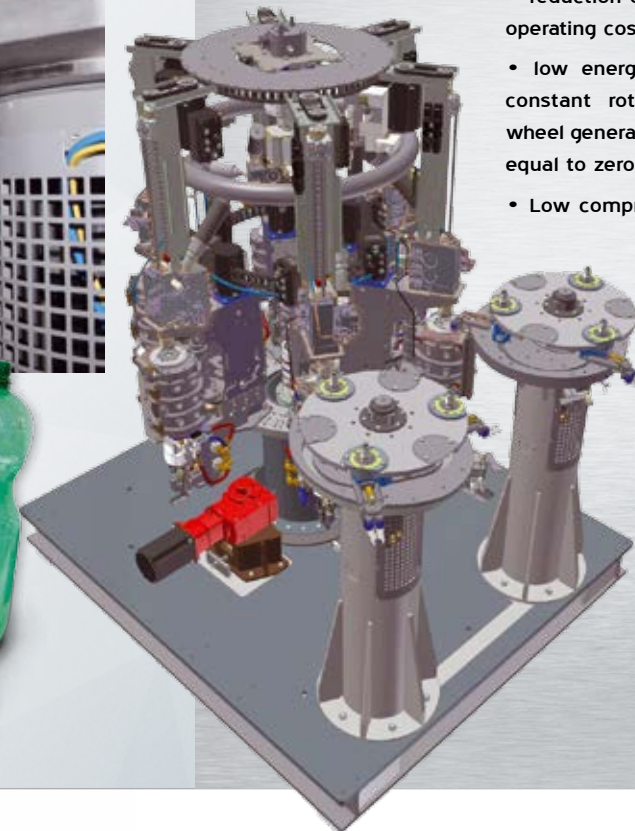

Features and benefits

» Top level reliability and efficiency

The new EBS ERGON series is more sturdy, compact, flexible, technologically advanced and performing than the previous series, thanks to an array of technical innovations applied to the stretch-blowing process.

As a matter of fact, the stretch-blowing module of the EBS ERGON range is equipped with motorized stretching rods whose operation, electronically controlled, needs no mechanical cams. Such innovation allows to precisely manage the stretching rod ride and to accurately control its position, while providing significant energy savings.

Furthermore, the new technology enables to change the stretching process speed without any mechanical interventions (cam replacement) and to remarkably reduce the vibration stress affecting the blowing wheel in traditional solutions.

The EBS ERGON series is also equipped with a system of valves featuring high performances and low dead volumes that allows to shorten the duration of pre-blowing and blowing operations for the benefit of machine yield, compressed air savings and the quality of bottles being manufactured.

» Easy and cost-cutting machine management, cleaning and maintenance

The stretch-blowmoulders of the EBS ERGON series stand out for their compact, ergonomic and functional configuration, capable of considerably simplifying the operations of machine management, cleaning and maintenance and of assuring significant space savings within the bottling facility. The protection doors of the new EBS ERGON models feature a slightly curved profile that provides broader space inside the machine so that the operator

can easily and safely carry out cleaning and maintenance interventions. New SMI blowers' ergonomics is further enhanced by the advanced technology used in the MotorNet System® automation and control system, that constantly keeps working parameters at optimal levels throughout the manufacturing process and allows the direct change of machine settings.

» Low noise and reduced mechanical stress

On EBS ERGON series' stretch-blow moulders a single servomotor takes care of operating both the up/down movements of the mould bottom and the opening/closing of the mouldholder group, thus remarkably reducing the mechanical stress and the noise level of this section of the machine compared with traditional cam-equipped solutions.

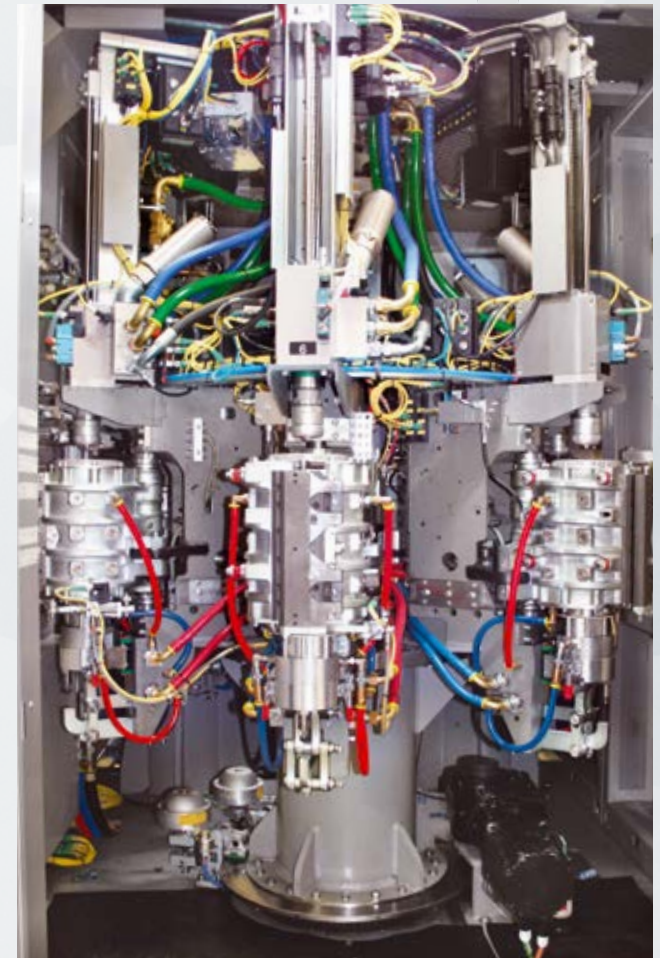

» New and compact preform-heating module

The stretch-blowmoulding machines of the EBS ERGON series are equipped with a newly designed preform-heating oven featuring compact size, horizontally deployed chain of preform-carrying mandrels (37/44 mm pitch for the blowing of containers up to 3 L and 54 mm pitch for the blowing of containers up to 10 L) and optimised ventilation and aeration system.

The cutting-edge concepts used in the design of the new ERGON machine range have allowed to shorten the oven by 50% in comparison with conventional equipment, thus reducing the number of preforms that in a given moment are passing in front of the heating panels.

The new heating module is equipped with a system of heat-reflecting panels made of highly energy-efficient composite material, deployed both in front of and behind the infrared ray lamps heating preforms up; such innovative solution allows a high degree of reflection of the heat generated by the lamps and, hence, assures a more uniform thermal distribution all over the preform surface.

Thanks to the cutting-edge technologies they feature, the new EBS ERGON blowmoulders by SMI stand out for low energy consumption and the utmost environment-friendliness of the stretch-blowmoulding process.

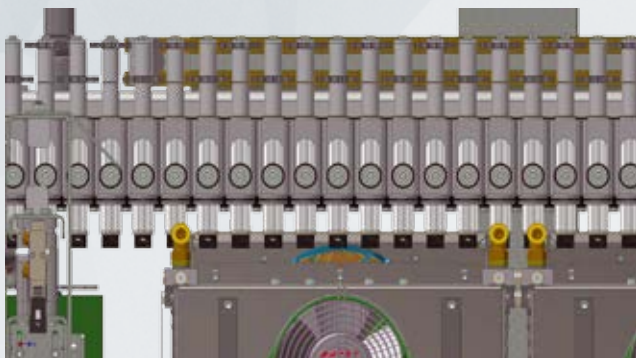

» High-performance reflective thermal panels to heat the preforms

Among SMI's main actions to reduce energy consumption, the one that stands out is the innovative heat-reflecting panel system mounted on the stretch-blow moulders both on the front and at the rear of the infrared ray lamps designed to heat the preforms. These panels, made of composite material, highly reflect the heat generated by the lamps, which operate at given wavelengths. The reflection process increases the intensity and quality of the thermal radiation to which the preforms are subjected, allowing a more uniform heat distribution over their entire surface and, consequently, the reduction of the number of lamps installed in the machine, as compared to traditional heating solutions. The greater energy efficiency of the foregoing innovative solution allows the end user to reduce the consumption of the electricity related to the power supply of the preform-heating lamps, with energy savings of up to 30% compared to traditional systems not equipped with this technology; of course, actual savings depend on system performance, size of the bottle to be manufactured, grammage and color of the preform used and other environment and production variables.

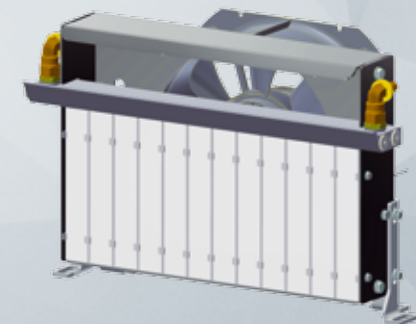

Features and benefits

» Preform orientator

- sturdy preform-lifting and orientating unit equipped with staircase and elevated platform
- recovery of the preforms in excess, carried back to the hopper automatically



» Rotary groups of grippers

- positively actuated valve gear control of the grippers' rotary groups through a double cam

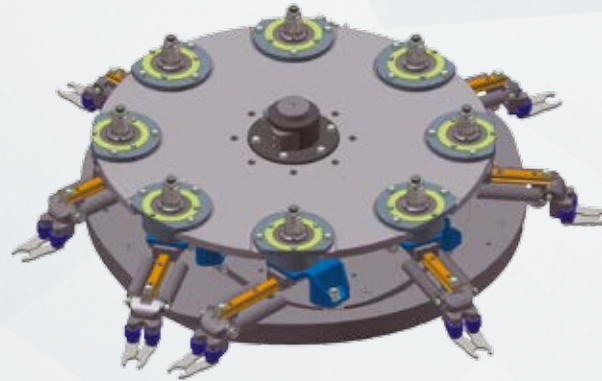

» Preform-heating module

- horizontally positioned infrared lamps, grouped in various sections
- up to 8 infrared lamps for each section of the heating module
- possibility to set and modify the parameters of each lamp through the POSYC operator panel
- preform heating lengthwise differentiated and radially homogeneous
- heat-reflecting panels, made of composite material, mounted on the front and at the rear of the infrared lamps to increase radiation intensity and, consequently, cut energy consumption
- mandrels chain pitch to 37/44 mm (for the blowing of containers up to 3 L) and 54 mm (for the blowing of containers up to 10 L)

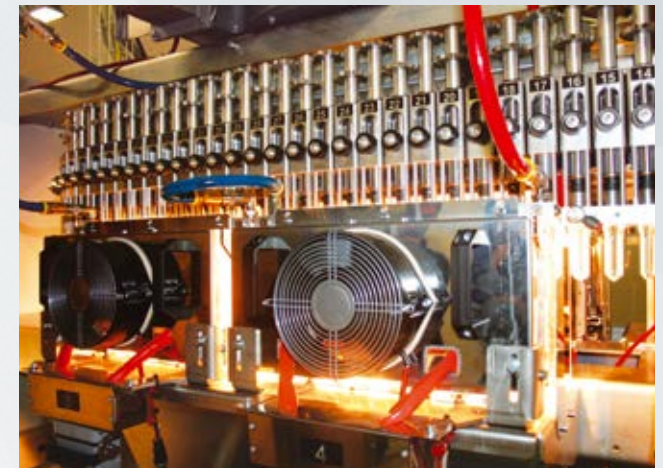

- liquid-fed cooling system, in order to cool the protection ring preventing the preforms thread deformation during the heating process
- air-fed cooling system, in order to keep the heating module temperature constant and low enough
- modular design, standardised for all stretch blow-moulders models

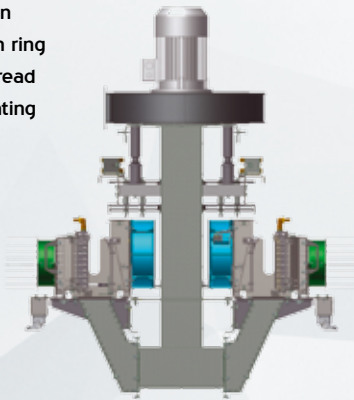

» Stretch-blowmoulding wheel

- precise and highly reliable cam-free technology
- standardized stretch-blowing stations for all blow-moulders models, with a low dead volume thanks to high performance valves and optimized circuits
- liquid-fed cooling system, in order to keep the moulds temperature constant
- air recovery system supplied as a standard equipment
- moulds treated on the surface and made from a special aluminium alloy highly resistant to wear
- motorized mould-holders made from an austempered iron casting highly resistant to mechanical stress
- motorized stretching rod to boost speed and enable a more flexible management of the stretching process.

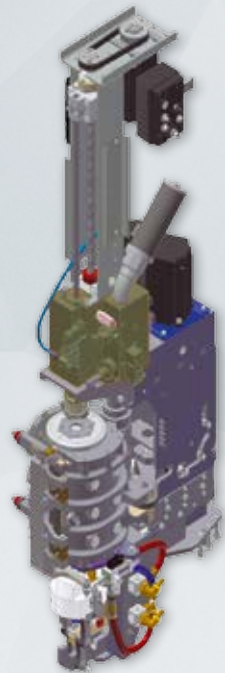

» Compressed air recovery system

- two exhaust valves for each stretch-blowing station: the first one introduces the air into the air recovery system tank, the second one discharges the air that can not be recycled
- considerable reduction of the energy costs and 40% saving in the compressed air consumption; thanks to the recovery system, a part of the air in the blowing circuit is recovered and recycled for the pre-blowing circuit and for the machine service air.
- the pressure of the pre-blowing circuit is controlled by an electronic adjusting device. If the pre-blowing circuit or the service air circuit do not need the recycled air, it is possible to use it for the low-pressure circuit of other external systems.
- use of eco-compatible, environment-friendly technology

COMPRESSED AIR RECOVERY SYSTEM

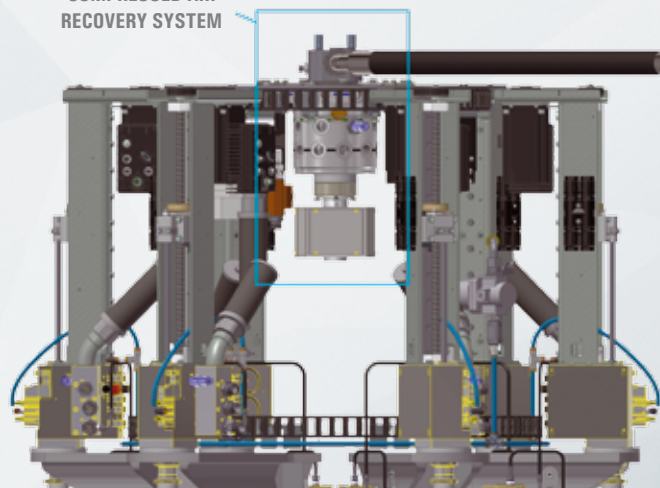

» Electrical panel and machine wiring

- electrical panel integrated in the heating module, thus reducing the machine overall dimensions; as a consequence, the final user has got larger space to install any optional equipment or additional accessories. Moreover, the machine structure is more compact and the access to it is easier, thanks to the elimination of the power cables (air or ground cables) that are generally used for the connection with the external electrical panels
- use of pre-assembled and pre-tested cables
- ethernet communication ring
- SERCOS interface™ field bus

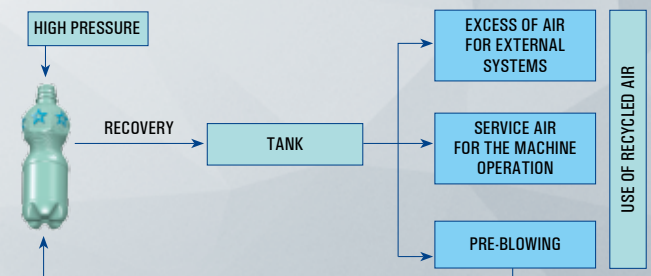



ECOBLOC® ERGON

SMI stretch-blow moulders are available either as stand-alone machine or integrated in complete systems of stretch-blowing, filling and capping.

In fact, ECOBLOC® ERGON series brings together the operations of a rotary stretch-blow moulder, of a electronic rotary filler or a level filler and of a rotary capper (a rotary labeller for the application of pre-glued labels can be supplied upon request).

ECOBLOC® ERGON systems are the ideal solution to blow, fill and cap (and to label if required) PET and PP rigid containers processed in bottling lines of still and carbonated water, soft drinks, milk and edible oil.

In more detail, ECOBLOC® machines range features:

- » ECOBLOC® VMAG/VMAS models, ideal for the production, filling and capping of rigid containers up to 3 liters for still liquids;
- » ECOBLOC® LG / LG-EP models, ideal for the production, filling and capping of rigid containers up to 3 liters for sparkling liquids;
- » ECOBLOC® HC (High Capacity) models, ideal for the production, filling and capping of rigid high capacity containers (up to 10 liters) for still liquids.

	ECOBLOC® V-MAG/V-MAS Series	ECOBLOC® LG/LG-EP Series	ECOBLOC® HC Series
N° Moulds (blowing)	from 4 to 16	from 4 to 16	from 3 to 6
N° Valves (filling)	from 15 to 114/90	from 25 to 126	from 9 to 21
N° Heads (capping)	from 5 to 18	from 5 to 18	from 3 to 4
Max output speed*	33,600 BPH	33,600 BPH	7,200 BPH
Container capacity	Up to 3L (min Ø = 44 mm max Ø = 108mm)	Up to 3L (min Ø = 44 mm max Ø = 108mm)	Up to 10L (min Ø = 44 mm max Ø = 215 mm)

*The stated values are not binding, as they have to be confirmed by SMI according to production conditions and preform/container technical specifications.

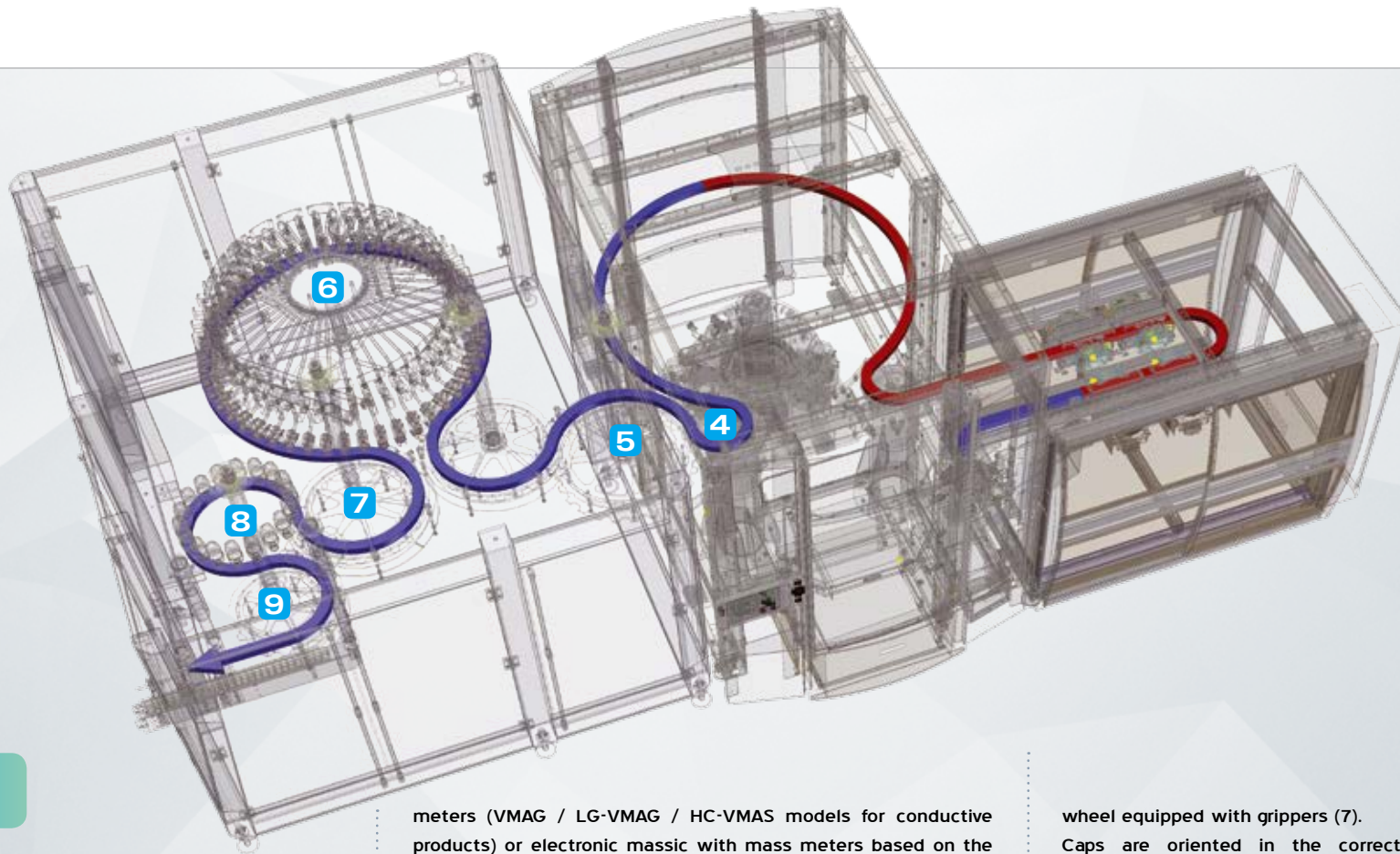

Operation

The bottles are conveyed directly from the blower to the filler neck-handling style by means of transfer star-wheels.

The star-wheel at the blowmoulder outlet (4) is equipped with grippers electronically-synchronised with the brackets of the star-wheel at the filler inlet (5).

A sensor detects the presence of the bottle at the filler inlet; the filling process starts only if a bottle is detected (6). The product to be bottled is fed from a small external tank to the filling valves by means of a pump or by gravity in the case of foam products.

The filling process is electronic volumetric with magnetic flow-

mers (VMAG / LG-VMAG / HC-VMAS models for conductive products) or electronic massic with mass meters based on the Coriolis' principle (VMAS / HC-VMAS models for non-conductive products).

A flowmeter positioned upstream of each filling valve gauges the amount of product flowing through.

The flow amount is gauged by pulses-counting: upon reaching the set amount of pulses for the current format, a signal is sent to the filling valve to be closed.

LG-EP models feature an electro-pneumatically controlled isobaric level filling system and the product level is given by the pipe entering the bottle. The filling stops when the product reaches the lower part of the air evacuation nozzle.

Full bottles are transferred to the capper (8) by means of a star-

wheel equipped with grippers (7).

Caps are oriented in the correct position by a hopper-unscrambler standing outside the machine at an easy-access height, and are transferred to a pick&place device positioning the cap under the capping head, which moves downwards and applies the cap on the bottle. A carousel (9) conveys capped bottles to an outlet conveyor with adjustable height, suitable for different bottle sizes.

In models provided with labeller, a carousel conveys the bottles to the automatic rotary labelling machine for the application of pre-glued adhesive labels. Centering heads hold the bottles still on rotary plates for label application and smoothing. Bottles are then discharged onto conveyor belts by means of a carousel positioned at the labeller's outlet.

Features and benefits

» Benefits

- modular compact frame, offering a wide array of customization options
- perfect separation between the “dry” environment of the stretch-blow moulding module and the “wet” environment of the filling module
- the “Baseless” technology employed allows for a minimum number of transfer star-wheels and for easier access to the blower and to the filler for maintenance and cleaning operations
- direct bottle transfer by means of adjoining star-wheels (neck-handling style with pitch circle diameter)
- the integrated system - excluding both rinser and connecting conveyors - drives down energy and water consumption
- dramatic cutback of TCO
- use of eco-friendly technologies, for the safeguard of the environment
- high cleanliness and hygiene standards
- excellent quality-price ratio



» The filling module

The “Baseless” technology employed on the filling module features the following benefits:

- area underneath the bottles completely clear, so as to ease the operator’s access to the machine for maintenance and cleaning operations
- lower maintenance and intervention times
- contamination-free and high-hygiene environment
- motors and transmissions placed in the upper part of the machine, in a dry and easy-to-inspect area
- manual dummy bottle system, for CIP operations

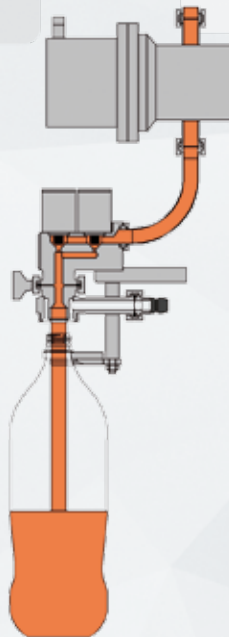

Electronic filling

ECOBLOC® ERGON integrated systems employ exclusively state-of-the-art filling technologies, with the following benefits:

- fully electronic management of the filling cycle
- filling parameters selection from the operator panel, according to product, container, speed
- simple-design, ready-to-clean filling valves
- easy and quick format changeover, with no need to replace mechanical components

Electronic volumetric filling:

ECOBLOC® VMAG/VMAS: FLAT LIQUIDS

- magnetic flow-meters, for flat conductive products ($> 50 \mu\text{S/cm}$), such as STILL WATER and MILK
- massic flow-meters, for flat non-conductive products ($< 50 \mu\text{S/cm}$), such as STILL WATER and EDIBLE OIL
- the flowmeter gauges the quantity of product (volume or mass) flowing through the pipe feeding the filling valve and turns it into pulses
- upon reaching a given number of pulses, the filling process stops



Isobaric electronic volumetric filling

ECOBLOC® LG-VMAG: CARBONATED LIQUIDS

- magnetic flowmeters, for carbonated conductive products (> 50 uS/cm) such as SPARKLING WATER and CSDs
- the flowmeter gauges the quantity of product (volume or mass) flowing through the pipe feeding the filling valve and turns it into pulses
- upon reaching a given number of pulses, the filling process stops.

Isobaric level filling with electro-pneumatic control

ECOBLOC® LG-EP/VMAG: CARBONATED LIQUIDS

- the position of the product level is given by a pipe entering the bottle
- the air in the bottle is evacuated by a nozzle fixed in the lower part of the filling valve
- the filling stops when the product level reaches the lower part of the nozzle



» The capping module

- Arol rotary capper
- high precision system, for the application of screw caps and pressure caps
- external cap feeding hopper
- shorter intervention time in case of cap jamming
- cap hopper-unscreamer with "waterfall" system (optional), delivers caps conveniently oriented to the feeding channel
- no more centrifugal hopper with relevant cap jamming hazard
- no more air thrust

» The labelling module

Upon request, ECOBLOC® compact systems can integrate a rotary labeller employing the innovative "Adhesleeve" technology from PE. Labellers, for the application of pre-glued adhesive labels.

The main benefits offered from such system are:

- no more hot melt glue and traditional label cutting
- adhesive pre-applied during label printing
- label and glue (water based) 100% recyclable
- one cylinder only for label cutting and dispensing
- no more critical passage between label cutting and feeding
- the film is cut with as many blades as the divisions in drum
- no cleaning operations required over a working shift
- the absence of hot melt glue and fix/rotating blades improves the line efficiency
- the "Adhesleeve" technology employs 20 micron transparent film (compared to 35 micron standard film), allowing for a 70% increase in the number of labels on a reel



Changeover

Thanks to their flexibility, SMI rotary stretch-blow molders are the ideal solution to produce a wide array of containers with one machine model.

Large vertically-sliding doors provide easy access to the machine components and to the moving organs from two sides.

Low changeover times allow to restart production immediately.

The parameters for each container are stored in the POSYC control panel, ready to be selected by the operator from the touch screen display.

The mechanical adjustments, the replacement of the molds and of any other component, if necessary, require few minutes and can be carried out by using the set of tools supplied with the machine.



Molds replacement

The changeover procedure consists of a few simple operations: opening of the mold-holder (1), removal of each half-mold (2) by loosening three screws, change of the mold bottom (3) by means of a mechanical hook (4) driven by a mechanical device (5), replacement of the stretching rod lock and selection of the new type of container from the POSYC control panel.

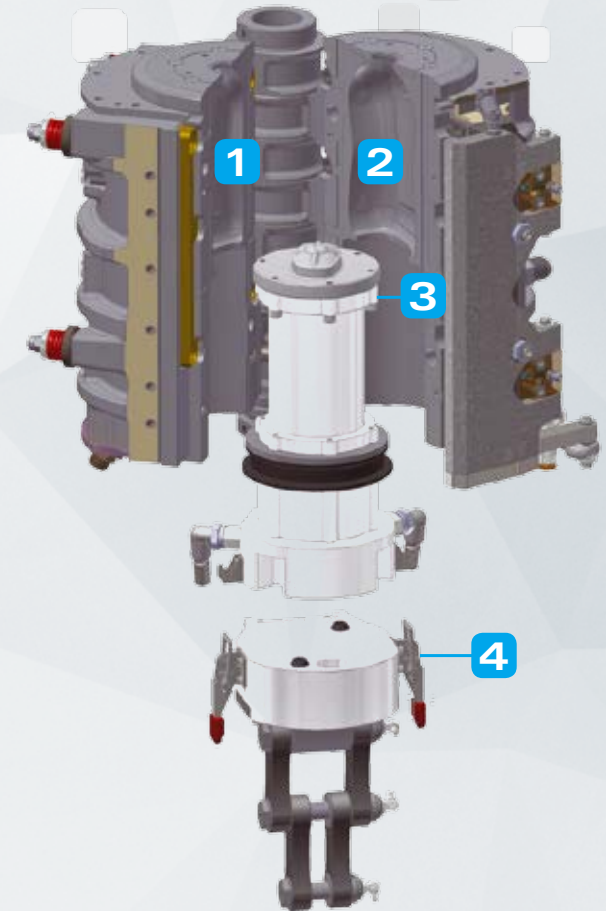

» PREFORMS AUTOMATIC LOADER

Allowing for a considerable reduction of loading time: in a few seconds, in fact, it is possible to load up to 2 pallets of preforms (depending on the blow-molder model).



» THREE STERIL FILTERS FILTRATION UNIT

The high-pressure air used in the stretch-blowing process of plastic containers (PET, PP, PLA, etc.) must comply with certain quality standards to allow for the pneumatic devices to work properly and to safeguard the equipment efficiency and integrity during its entire life cycle.

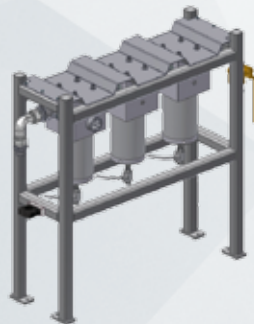

The filtration unit is composed of a metal "bar" to which three filter-cartridges containers are fixed, in order to provide three filtration stages:

1. coalescing pre-filtration: for the removal of solid particles, water and oil;
2. active carbon filtration: for the removal of odors and oil vapors;
3. final filtration for sterile air.

» SUCTION OF THE SPACER STAR WHEEL

In any bottling line, the hygiene of the product and of the container is crucial.

Thanks to the installation of a special spacer star-wheel, the preforms undergo an accurate cleaning process before entering the heating module.

Special nozzles remove any residual dust or microscopic particles from inside the preforms.

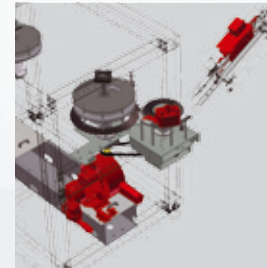

» MOLD STORAGE TROLLEY AND SET OF TOOLS FOR EXTRAORDINARY MAINTENANCE

In order to make changeover and extraordinary maintenance operations easier and quicker, SMI can supply a set of tools and a mold storage trolley, with a capacity of up to 15 molds on SR / SR HP machine models and up to 4 molds on SR HC models.



» CHILLER

In order to cool the heating module and the blowing-wheel, SMI offers different models of air coolers, suitable for indoor installations.



» AUTOMATIC DUMMY BOTTLES SYSTEM

ECOBLOC® integrated systems feature - as an option - a device for the automatic insertion of dummy bottles during the machine sanitization and cleaning process (CIP).

The bottles are lifted, screwed to the filling valve and discharged at the end of the cleaning cycle; such system prevents any contact between the operator and the machine, staving off the relevant product contamination hazards.

The process automation allows as well to drive down CIP operation times.

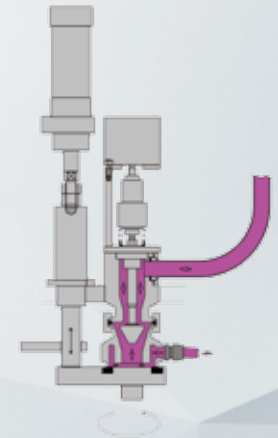



» Design of the containers

SMI relies on an advanced 3D CAD Department for the design and graphic processing of the bottles.

After an accurate analysis of the customer's requests, the container idea is developed and turns into a detailed project.

Up to now, SMI engineers have designed over 1.000 different containers, featuring from the most simple to the most sophisticated shape.

» Mold production

The molds mounted on SMI stretch blow-molders are made of a special aluminium alloy and are manufactured by Smimec, a company equipped with an FMS line consisting of 12 CNC machining centres: highly automated machines, running 7 days a week round

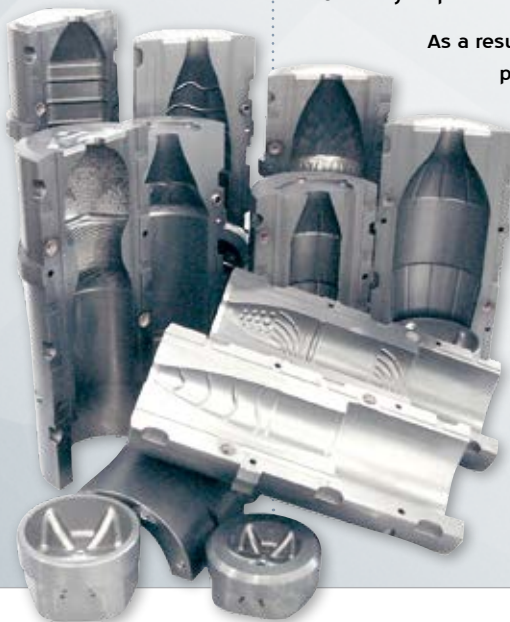

the clock, even operator-less, according to pre-set production programmes (CAM).

The 12 machining centres can achieve an output of more than 15.000 molds per year: they are equipped with linear motors with a speed rate up to 80 meters per minute and mandrels achieving a speed rate of 30.000 rounds per minute.

As a result, top-level quality standards are constantly provided.

» Preform checks

In a state-of-the-art laboratory, equipped with sophisticated technologies, the customer's preforms are accurately tested before entering the stretch-blowing unit.

In particular, the preforms size is checked by a videocamera, while a special software for the comparison of dimensional parameters measures the preform walls thickness by means of

infrared rays and checks the polymer homogeneity by means of polarized light equipment.

SMI constantly invests in research and development activities, such as testing new materials and applications, especially multi-layer or hot-filling preforms.

» Container tests

All the containers produced by stretch blow-molding are tested to check their mechanical-thermal features, that is:

- top load
- drop impact resistance
- resistance to deformations
- thermal stability
- homogeneous distribution of the resin
- burst pressure
- stress cracking



» In the SMI blow-molders and fillers, the fully automatic processes, the electronically-controlled and the wiring by field bus are synonyms of reliability, considerable operational flexibility and high performance.

The hardware and software components are "open" and modular, in compliance with the most important international certifications and rely upon consolidated standards of the industrial field and of the packaging sector: OMAC guidelines (Open Modular Architecture Controls), sercos, PROFIBUS, IEC61131, OPC, Industrial PC.

In particular, by following the OMAC guidelines and the Omac Packaging Workgroup (OPW), SMI can guarantee easy integration with the other machines in line, user friendly technology and maintenance of the investment value.

The automation and control system of SMI machines, called MotorNet System®, includes the following hardware components: MARTS (process controller), POSYC (man-machine interface), COSMOS (digital servodriver for



brushless motors), dGATE and aGATE (remote IP65 I/O digital/analogic modules).

The MARTS is a PAC (Programmable Automation Controller), based on an industrial PC, which can be programmed in IEC61131 languages.

The COSMOS servodrivers and the dGATE/aGATE I/O modules are connected to the PAC via sercos .

The POSYC is a HMI terminal, (touch screen IP65), based on an industrial PC with solid state drives.

MotorNet System®



SMI stretch blow-molders are very easy to use; in fact, thanks to the MotorNet System® technology, it is possible:

- To set the heating profile for each preform and the parameters influencing the phases of the stretch-blowing process (from when the preform enters the heating module up to the container);
- To adjust the power of each lamp in each section of the heating module;
- To control the operation parameters of each stretch-blowing station and monitor the whole stretch-blowing process in real time;
- To store the parameters of each container blown;
- To check and set the machine production speed, according to the different types of containers;
- To change format quickly and easily;
- To solve or prevent any problems, thanks to the teleservice, the graphic alarms displayed on the POSYC and the signal of the maintenance interventions to be carried out;
- To have direct access to the manuals on the POSYC;
- To ensure high outputs, excellent quality and low noise levels;
- To monitor the performance and analyse the down-times (Pareto diagram);
- To interchange the POSYC with compatible Panel PC;
- To interchange the COSMOS with compatible sercos pack profile servodrivers.

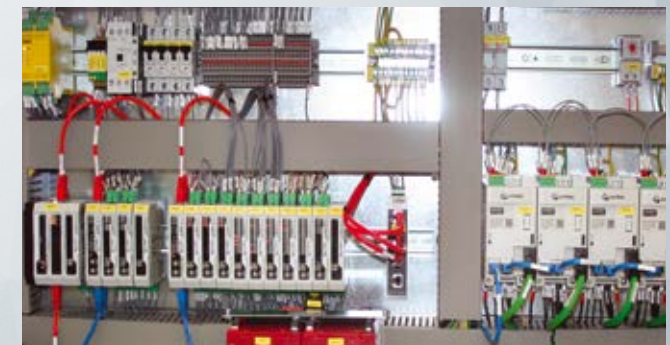



www.smigroup.it



SMI S.p.A.

Via Carlo Ceresa, 10
I-24015 San Giovanni Bianco (BG)
Tel.: +39 0345 40.111
Fax: +39 0345 40.209
E-mail: info@smigroup.it